

# MEASUREMENT DIAGRAM

## PLACEMENT - OUTER ALUMINIUM POSTS

### OUTER CORNER

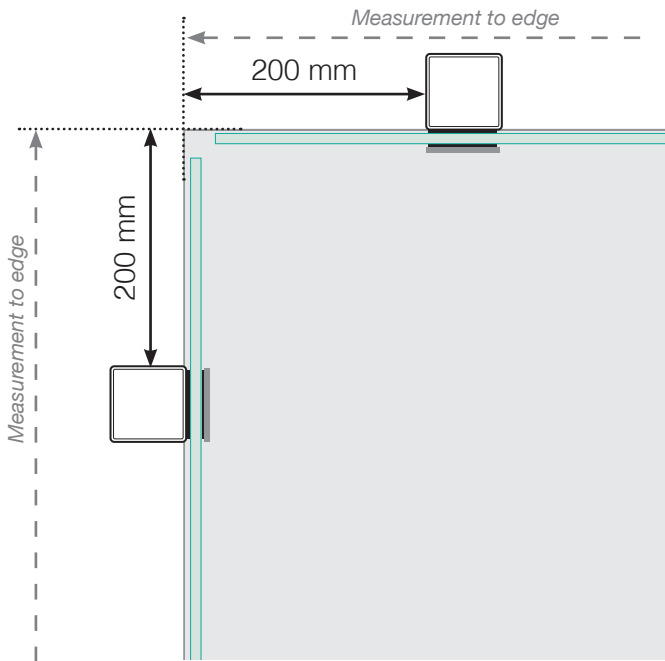

### OUTER CORNER NOT 90°

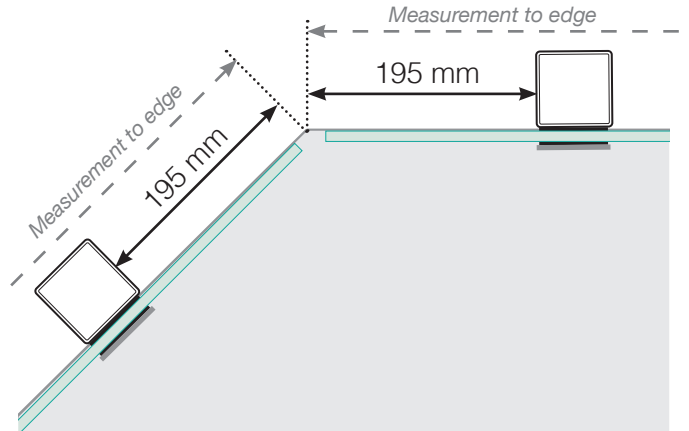

### INNER CORNER NOT 90°

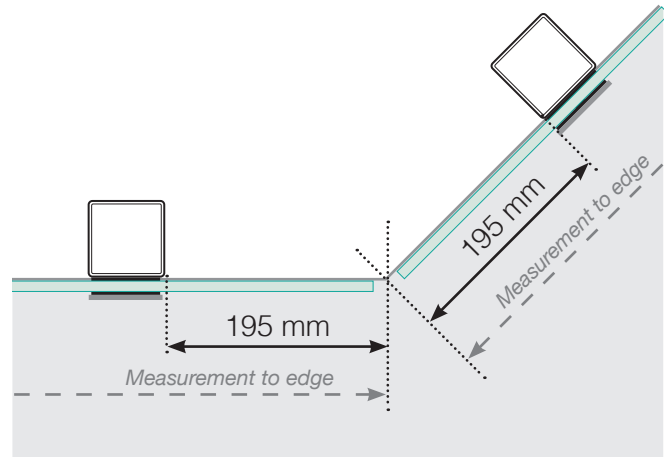

### INNER CORNER

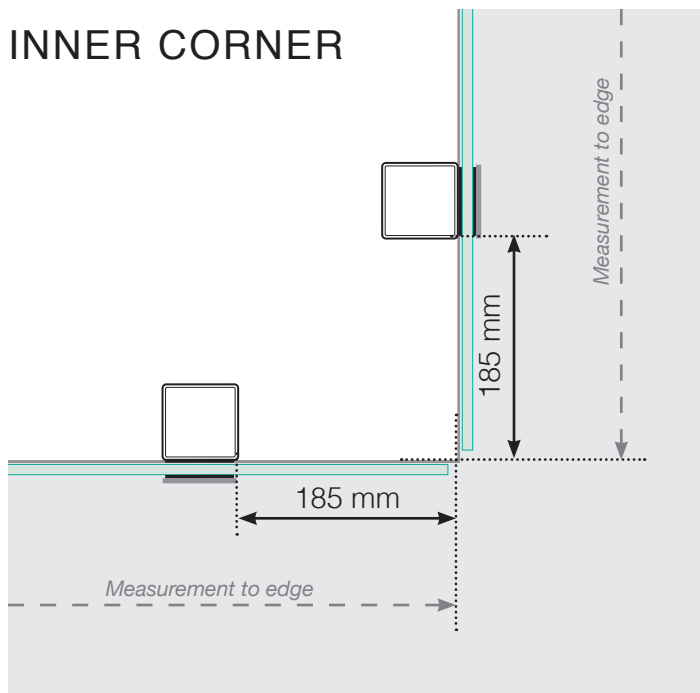

### END

Free-standing

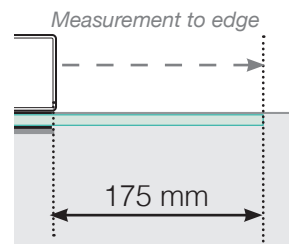

By the wall

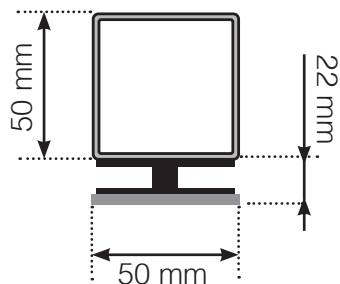
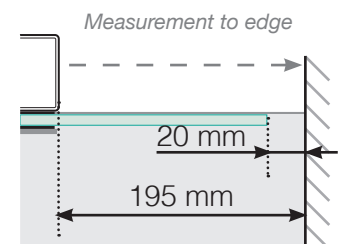

### DISTANCE BETWEEN STRAIGHT SECTIONS

